



**INSTRUCTIONS D'ASSEMBLAGE**  
**ASSEMBLY INSTRUCTIONS**

---

**M**ONARCH  
SPECIALTIES INC.

# I 3290

---

**ETAGERE -**  
**60" H / BLANCHE LUSTRE AVEC VERRE TREMPE**

**BOOKCASE -**  
**60" H / GLOSSY WHITE WITH TEMPERED GLASS**





**POUR DE L'ASSISTANCE OU POUR COMMANDER  
DES PIÈCES CONTACTEZ NOTRE DÉPARTEMENT  
DE SERVICE À LA CLIENTÈLE.**

**FOR ASSISTANCE OR TO ORDER PARTS  
CONTACT OUR CUSTOMER SERVICE DEPARTMENT**

**[WWW.MONARCHSERVICE.COM](http://WWW.MONARCHSERVICE.COM)**

---

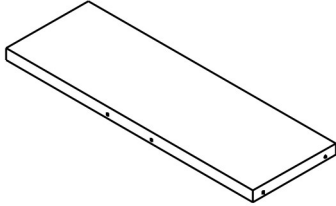
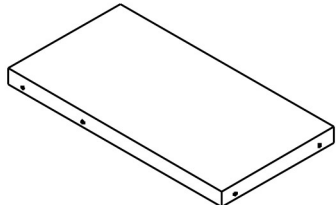
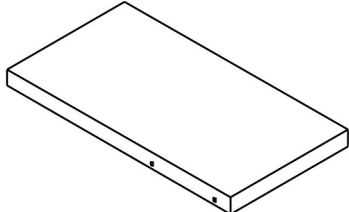
**LISTE DES PIÈCES**  
**PARTS LIST**

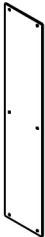
PIÈCE / PART #	IMAGE	DESCRIPTION	QTY / QTÉ
1		TOP SHELF ÉTAGÈRE SUPÉRIEURE	1
2		SHELF PANEL PANNEAU DE TABLETTE	2
3		SHELF PANEL PANNEAU DE TABLETTE	1
4		GLASS PANEL (LEFT) PANNEAU EN VERRE (GAUCHE)	1
5		GLASS PANEL (RIGHT) PANNEAU EN VERRE (DROIT)	1

**LISTE DES PIÈCES**  
**PARTS LIST**

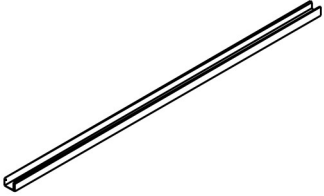
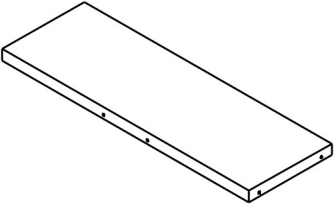
PIÈCE / PART #	IMAGE	DESCRIPTION	QTY / QTÉ
6		<p align="center">GLASS PANEL                      PANNEAU EN VERRE</p>	1
7		<p align="center">PLASTIC BAR                      BARRE DE PLASTIQUE</p>	2
8		<p align="center">BOTTOM SHELF                      ÉTAGÈRE DU BAS</p>	1

**LISTE DES PIÈCES DE MONTAGE**  
**HARDWARE LIST**

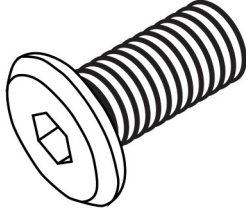
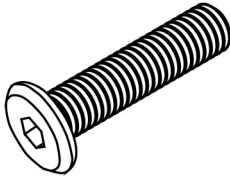
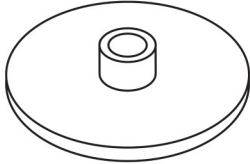
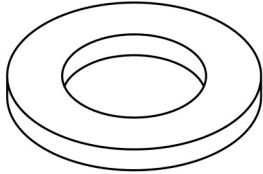
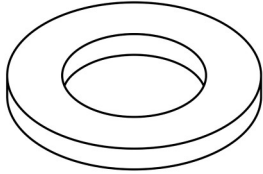
PIÈCE / PART #	IMAGE	DESCRIPTION	QTY / QTÉ
<b>A</b>		<b>ASSEMBLING BOLT -</b> <b>Ø1/4" X 1/2"</b>  <b>BOULON D'ASSEMBLAGE -</b> <b>Ø1/4" X 1/2"</b>	<b>10</b>
<b>B</b>		<b>ASSEMBLING BOLT -</b> <b>Ø1/4" X 1 7/8"</b>  <b>BOULON D'ASSEMBLAGE -</b> <b>Ø1/4" X 1 7/8"</b>	<b>14</b>
<b>C</b>		<b>SCREW CAP -</b> <b>Ø1/4" X 1 3/8"</b>  <b>CAPUCHON DE VIS -</b> <b>Ø1/4" X 1 3/8"</b>	<b>14</b>
<b>D</b>		<b>PLASTIC WASHER -</b> <b>Ø3/4"</b>  <b>RONDELLE DE PLASTIQUE -</b> <b>Ø3/4"</b>	<b>10</b>
<b>E</b>		<b>PLASTIC WASHER -</b> <b>Ø1 1/4"</b>  <b>RONDELLE DE PLASTIQUE -</b> <b>Ø1 1/4"</b>	<b>28</b>

**LISTE DES PIÈCES DE MONTAGE**  
**HARDWARE LIST**

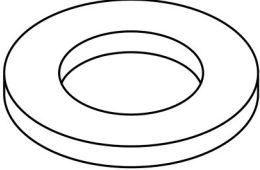
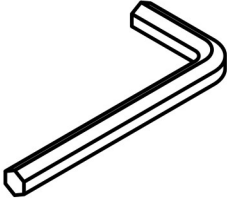
PIÈCE / PART #	IMAGE	DESCRIPTION	QTY / QTÉ
F		METAL WASHER - Ø3/4" RONDELLE DE MÉTAL - Ø3/4"	14
G		HEX KEY CLÉ HEXAGONALE	1



OUTIL DE VÉRIFICATION DE DIMENSIONS DES PIÈCES  
HARDWARE DIMENSIONS VERIFICATION TOOL



ÉTAPE / STEP 1

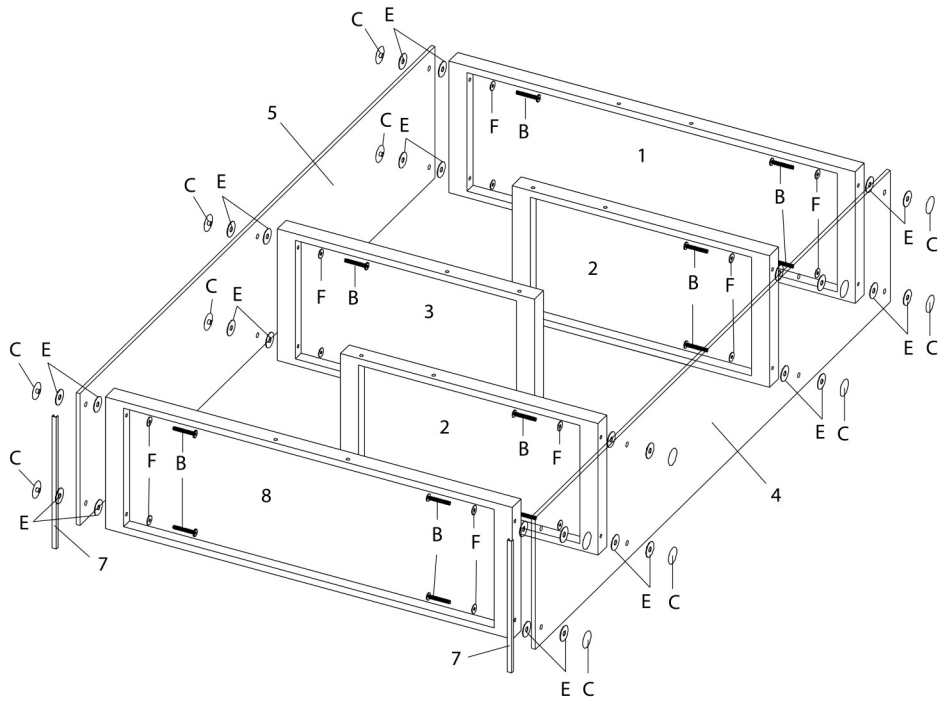

ÉTAPE / STEP 2

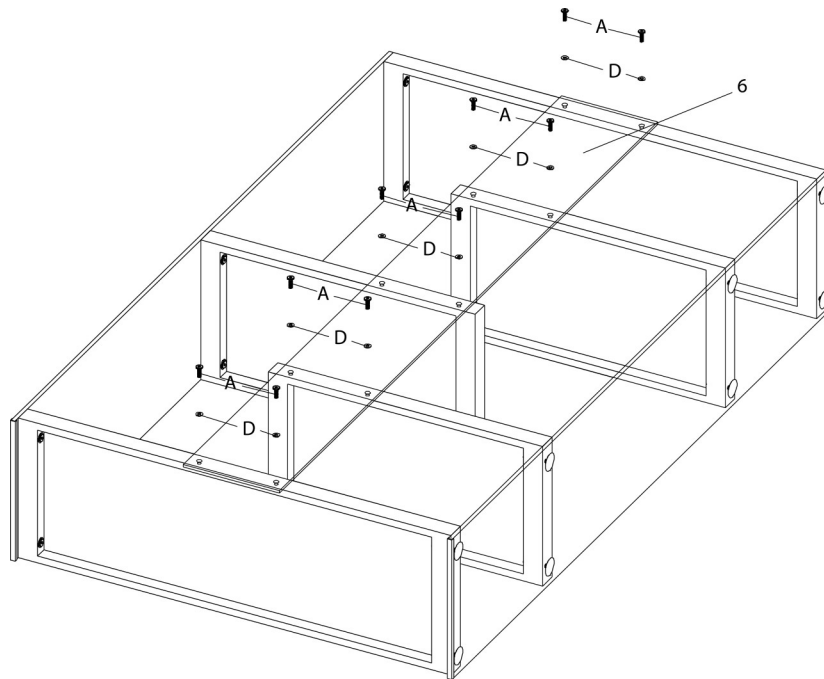

ÉTAPE / STEP 3

